



'RUN DRY UTILITY PUPPIES' 23920-SERIES

RUN DRY UTILITY PUPPY PERFORMANCE		
Approximate performance for new pump, pumping water at 20°C, with fully charged battery		
Total Manometric Head	23920-9403	23920-9213
	23920-9503	23920-9313
ftH ₂ O	gpm	gpm
0	10	13.2
3.5	9.6	12.6
7	9.3	12
13	8.0	10.8
20	6.6	10
26		9
33		8
39		6.6

GENERAL DETAILS
Run Dry Utility Puppy Models 23920-9403 / 9503 Will self prime up to 4 feet Lip type water seal fitted
Run Dry Utility Puppy Models 23920-9213 / 9313 Will self prime up to 8 feet Mechanical type water seal fitted
<ul style="list-style-type: none"> • Both models have 3/4" NPT threaded ports • All models will run dry for up to 10 minutes after initial prime • All models comply with USCG Regs for Ignition Protection • Always use a bilge strainer to prevent pump blockage

IMPORTANT ELECTRICAL INFORMATION
1. Connect black wire to NEGATIVE (-) battery terminal. Red wire should run via a suitably rated switch and fuse to a POSITIVE (+) battery terminal. NOTE: Wrong wire connections will cause motor and pump impeller to run in reverse which may result in motor damage.
2. Pump warranty will be invalidated if pumps are operated without a fuse.
3. Ensure battery capacity is adequate for ALL electrical equipment (pumps, radio, TV, refrigerator, navigational instruments).
4. Regularly check battery state of charge and recharge if necessary.
5. Inadequate supply voltage at the motor terminals (not less than 10% below rated voltage at full load) due to partially discharged battery or voltage loss through long or small size electric wire may cause blowing fuses or pump starting problems. Please consult recommended minimum cable size.
6. If fuse fails repeatedly, check reason why. DO NOT FIT HEAVIER FUSE OR BRIDGE FUSE TERMINALS WITH SILVER PAPER OR METAL (NON FUSE) WIRE. Failure to observe this instruction may damage motor or cause FIRE HAZARD due to overheating of electrical wiring.

MOTOR SPECIFICATION
12V or 24V DC Continuous
Permanent Magnet
Conforms to USCG Regs for Ignition Protection
Conforms to BSEN 50081 (Electromagnetic Compatibility)
Motor Cable Length 9 3/4"

ELECTRICAL WIRING INFORMATION					
Model No.	Voltage	Amp Draw	Maximum Fuse Size	Minimum Wire Size AWG	Max. length of wire between (+) & (-) battery terminals
23920-9213	12V	21 amp	25 amp	10 8	up to 20 ft over 20 ft
23920-9313	24V	11 amp	15 amp	12 10	up to 20 ft over 20 ft
23920-9403	12V	13 amp	15 amp	14	15 ft
23920-9503	24V	7.5 amp	10 amp	14	15 ft

ITT Jabsco				
USA ITT Jabsco 1485 Dale Way, Costa Mesa, CA 92628-2168, U.S.A Tel: +1 714 646 8261 Fax: +1 714 957 0600	UK ITT Jabsco Bingley Road, Hoddesdon, Hertfordshire, EN11 0BU, U.K. Tel: +44 (0)1992 460146 Fax: +44 (0)1992 467132	CANADA ITT Fluid Products Canada 66 Royal Road, Guelph, Ontario N1h 1T1, Canada Tel: +1 519 821 1900 Fax: +1 519 821 2669	JAPAN NHK Jabsco Co Ltd. 3 - 21 - 10, Shin - Yokohama, Kohoku - ku, Yokohama 222, Japan. Tel: +81 (0)45 476 8908 Fax: +81 (0) 45 476 8908	GERMANY MINTEC GmbH 22844 Nordestadt, Germany Tel: +49 (0)40 6363730 Fax: +49 (0)40 63637311



'RUN DRY UTILITY PUPPIES' 23920-SERIES

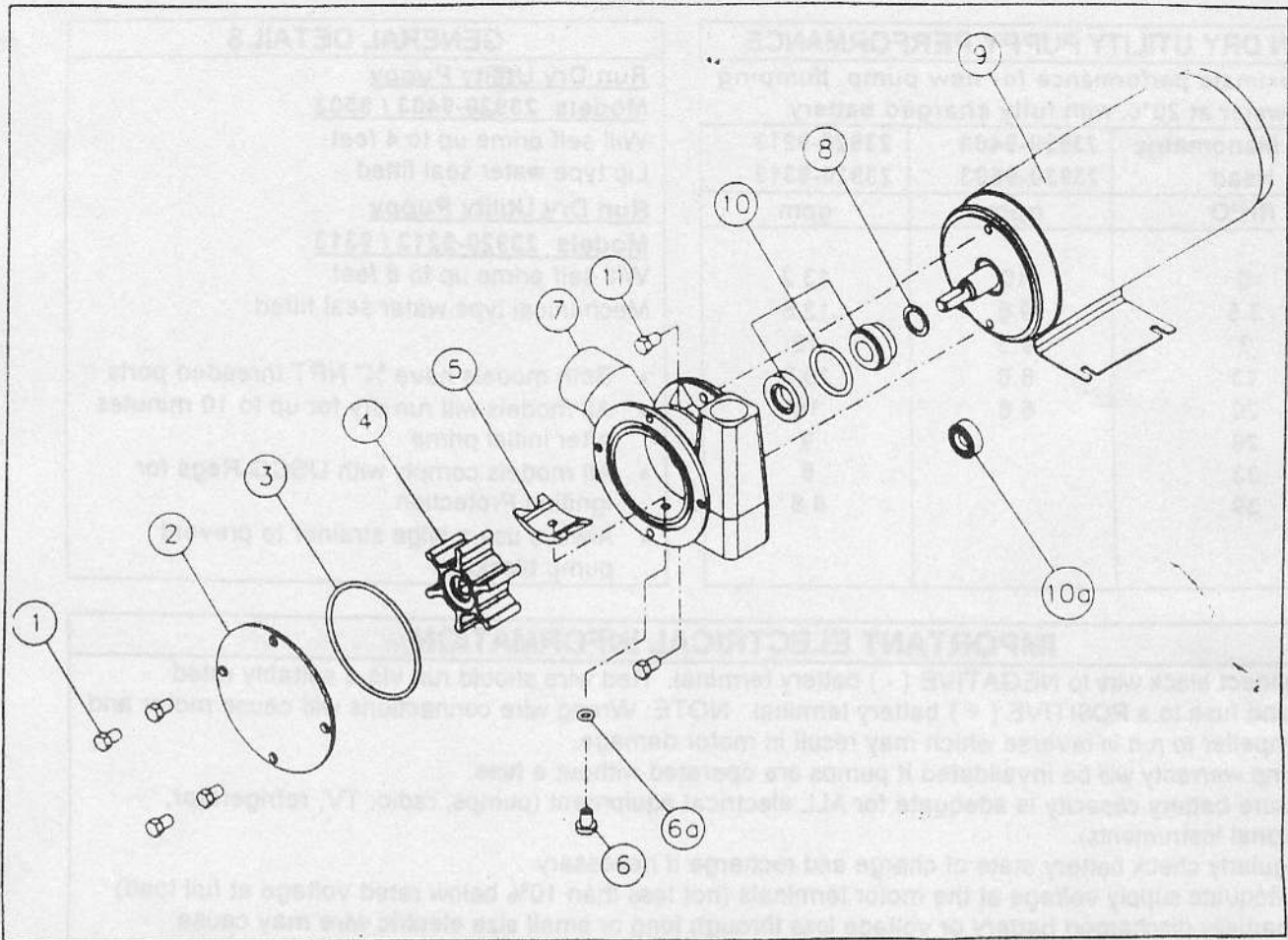

RUN DRY UTILITY PUPPY PARTS LIST

KEY	DESCRIPTION	23920-9213/-9313		23920-9403/-9503	
		QTY	PART NUMBER	QTY	PART NUMBER
1	End Cover Screws	4	X3001-147F	4	X3001-147F
2	End Cover	1	23825-0000	1	23825-0000
3	End Cover Seal	1	X4020-257A	1	X4020-257A
4	Impeller - Nitrile	1	7273-0003	1	6303-0003
5	Cam	1	53023-0000	1	53023-0100
6	Cam Screw	1	X3002-147F	1	X3002-147F
6a	Cam Screw Seal	1	X4020-105A	1	X4020-105A
7	Pump Body	1	53024-9000	1	53024-9100
8	Slinger	1	6342	1	6342
9	Motor	1		1	
	Standard Impeller 12V		SP8012-0261		SP8012-0165
	Standard Impeller 24V		SP8012-0262		SP8012-0166
10	Mechanical Water Seal	1	SP8012-0301B		
	Lip Type Water Seal			1	SP2701-52
11	Pump/Motor Screws	2	X3001-147F	2	X3001-147F
12	Grommet (Motor Foot)	4	SP2900-12	4	SP2900-12
	Motor Brush & Brush Holder Assy.		SP304-816-20		25522-0000

