

“CYCLONE PUMP”

Stainless Steel DC Motor / Pump Unit

A range of Stainless Steel General Purpose Centrifugal pumps designed specifically for the marine and industrial markets. Typical applications would be for circulation applications such as hot water systems, livewell or bait tank installations.



Features & Benefits

- Heavy duty robust design
- Stainless steel construction
- Long life DC motor
- Silent running
- Anti-clog impeller design
- Long life mechanical seal
- Single tool servicing

Specification

- Recommended Duty - Max. 30 minutes on, Min. 30 minutes off
- Motor life 2500 hours
- 2m suction lift when wetted
- Fluid temperature +4°C min +95°C Max



WARNING: Continuous running of pump will cause motor casing to get hot. DO NOT touch - burns may occur.



WARNING: Do not pump petrol or fluids with a flash point below 37°C (98°F). Explosion and death may occur.

Performance Curve

50870-Series Cyclone Performance
Typical performance based on pumps running at 12.8V and 25.6V DC

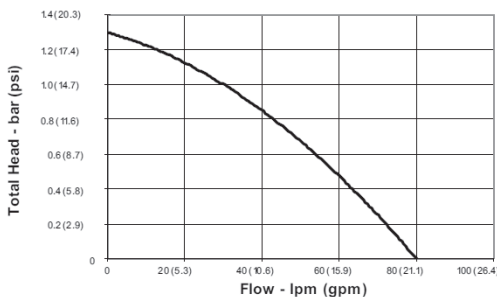

Part Numbers

Model	Voltage	Port Fitting
50860-2012	12Vdc	NPT
50860-2012	12Vdc	BSP
50860-0024	24Vdc	NPT
50860-2024	24Vdc	BSP

Relevant Standards

- ISO 8846 MARINE and USCG Regulations for Ignition Protection
- ISO 8849 MARINE Bilge Pump Standard

Installation Instructions

- The Cyclone can be mounted on any flat surface.
- The pump must be installed below the lowest fluid level to maintain flooded suction.
- Fit pump in a dry, well ventilated position.
- Use rubber grommets provided to minimise vibration.
- If mounted vertically, ensure the motor is above the pump head.
- Use 3/4" pipe fittings with PTFE pipe joint tape or compound.
- Plastic fittings should not be used if pump is installed below the waterline.



WARNING: All marine pumps discharging overboard must be installed with the overboard discharge well above both static and heeled waterlines. Flooding and death may occur.

Operation

- Pump may be run dry for short periods of time.
- Pump may be run against a closed discharge.

Maintenance

- Check all electrical connections periodically.
- Check seal area for signs of leaking.

Spare Parts List

See Exploded View (page 4) for explanation of parts key.

(A) Pump Head Kit (NPT)	50864-0000
Pump Head Kit (BSP)	50864-2000
(B) Seal Kit	50865-0000
(C) Motor Kit (12V)	50866-0012
Motor Kit (24V)	50866-0024

Key	DESCRIPTION	KIT KEY			QTY PER KIT
		A	B	C	
1	End Cover	1			1
2	Screws	5	5		5
3	O-Ring	1	1		1
4	Locking Nut	1	1		1
5	Impeller	1			1
6	Seal		1		1
7	Housing	1			1
8	Slinger		1		1
9	Motor			1	1



WARNING: Motor may get hot after prolonged use, do not touch. Burns may occur.

Wiring Instructions

- All electrical wiring should be connected and installed by a competent electrician. A qualified person must ensure that the installation conforms to the regulations in place.
- Ensure connections are of the correct polarity red/orange (+ve) black negative (-ve). Note; if wired in reverse the pump will still run but give poor performance.
- Always use the correctly rated fuse or circuit breaker. If a circuit breaker is used it should be of the “conditionally surge current proof” type. Please see document 43010-0272 for recommendations or consult the factory if more advice is needed.
- Check that the supply voltage is compatible with the voltage specified on the label. A discharged battery will result in reduced pump performance.

Wiring Diagram

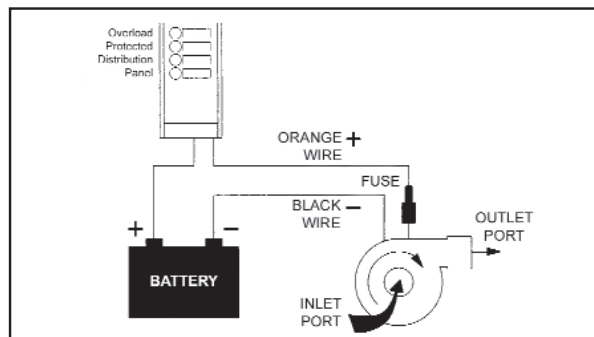



WARNING: If the fuse fails repeatedly, do not fit a heavier fuse or bridge the terminals. Fire and death may occur.

Wire Size Table

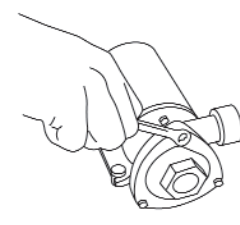

Model Number	Voltage	Maximum Current	Fuse Size	Wiring Size		
				AWG	mm ²	Max. Length*
50860-XX12	12V	21A	25A	10	6.0	4.5m (15 ft)
				6	15.0	9.0m (30 ft)
50860-XX24	24V	210.5A	15A	12	4.0	4.5m (15 ft)
				10	6.0	9.0m (30 ft)

* wire length from battery to pump and back to battery, maximum voltage drop 3%

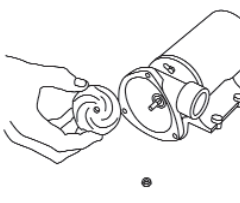
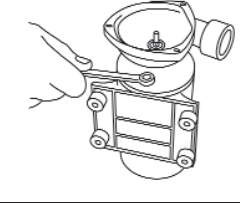
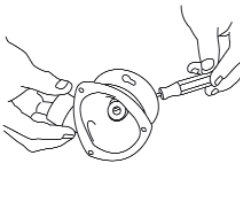
Dis - Assembly

1	Disconnect pump from power supply. Remove 3 end cover bolts, end cover & o-ring.	
2	Carefully holding impeller, remove impeller nut.	
3	Remove impeller.	
4	Loosen 2 head fixing bolts, rotate pump head and pull to remove.	
5	Remove seals from pump body.	

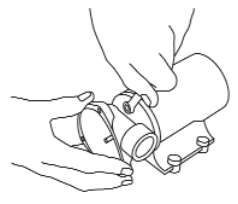
Re - Assembly

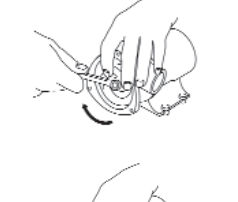
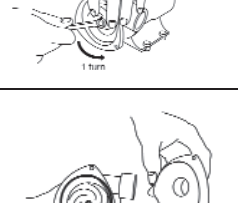
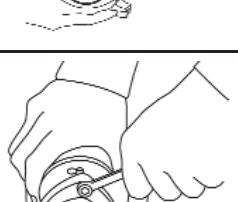
6	Wet the flat seal part and cup rubber and push into head.	
7	Fit head to motor locking into position and tighten head fixing bolts.	
8	Lubricate inside of mechanical seal and push onto shaft.	
9	Fit and carefully hold impeller and tighten nyloc nut. Once tight, carefully hold impeller and undo nut 1 revolution to set impeller clearance.	
10	Fit o-ring to the body, then place on the head.	
11	Tighten 3 end cover bolts.	

JABSCO®

50860 Series High Pressure Centrifugal Pump

Dimensional Drawing

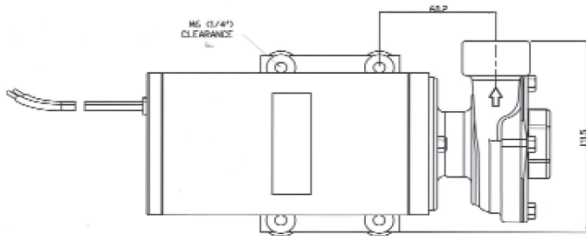

Dimensions in mm (inches)
Weight: 10.5kg (23.1lb)

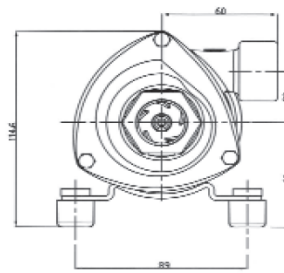
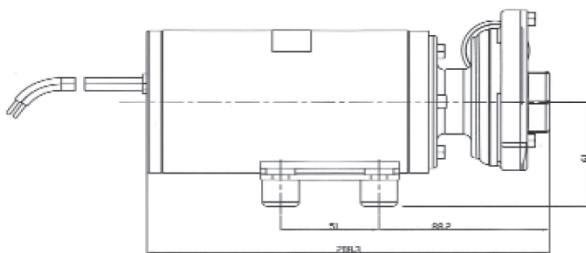

Exploded View

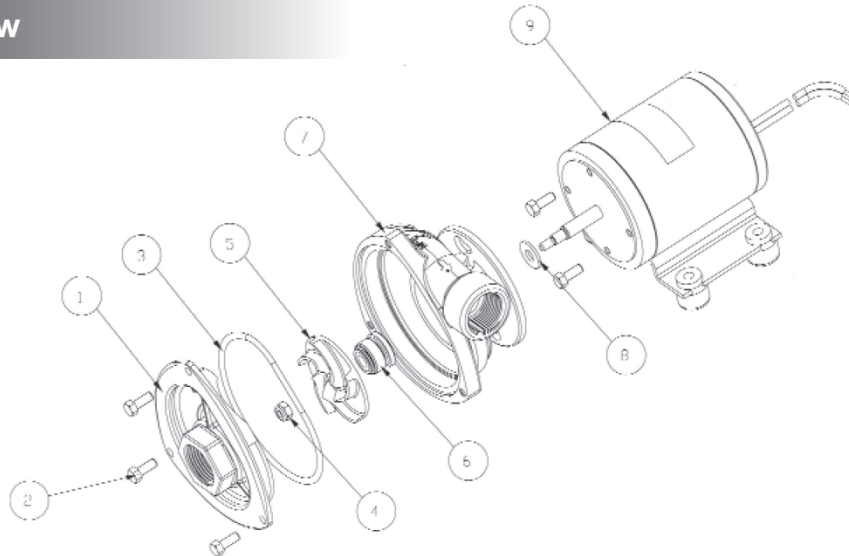

xylem
Let's Solve Water

Jabsco, 1 Kondelin Road, Cape Ann Industrial Park, Gloucester, MA 01930
Tel: +1 978 281 0440 Fax: +1 978 283 2619

USA

Jabsco, Bingley Road, Hoddesdon, Hertfordshire, EN11 0BU
Tel: +44 (0) 1992 450 145 Fax: +44 (0) 1992 467 132

UK

NHK Jabsco Co Ltd, 3-21-10, Shin - Yokohama Kohoku-ku, Yokohama 222
Tel: +81 (0) 45 475 8906 Fax: +81 (0) 45 475 8908

JAPAN

Jabsco GmbH, Oststraße 28, 22844 Norderstedt
Tel: +49 (0) 40 53 53 73 0 Fax: +49 (0) 49 53 53 73 11

GERMANY

Jabsco Italia, s.r.l., Via Tommaseo, 6, 20059 Vimercate, Milano
Tel: +39 039 685 2323 Fax: +39 039 666 307

ITALY

Warranty: All products of the company are sold and all services of the company are offered subject to the company's warranty and terms and conditions of sale, copies of which will be furnished upon request. The information provided herein is for guidance only, it does not constitute a guarantee of the performance or specification of any individual product or component.

© 2012 Xylem, Inc. All rights reserved. JABSCO is a registered trademark of Xylem Inc. or one of its subsidiaries.