



Models 31820-Series
31821-Series

INDUSTRIAL DIAPHRAGM PUMPS

Commercial Duty, 3 GPM/12 LPM

FEATURES

- Sealless
- Run Dry Ability
- Self-Priming
- Thermal Overload Protected Motor
- Corrosion Protected Motor
- Snap-in 1/2" (13 mm) Dia. Port Adaptors
- Conforms to Electromagnetic Compatibility 89/336/EEC and Machinery Directive 89/392/EEC, EN50081-1
- Easy Installation
- Flow to 3 GPM/12 LPM
- Low Amp Draw
- Compact Size
- Quiet Running

SPECIFICATIONS

Pump Body:	Glass Filled Polypropylene
Elastomers:	Santoprene** Diaphragm, Valves of Viton*
Hardware:	Stainless Steel
Pump Design:	Multi-Chamber Diaphragm
Suction Lift:	Self-Priming to 10 ft (3 m) (wet) 5 ft (1.5 m) (dry) min.
Duty Cycle:	Continuous, Maximum 40 psi (2.8 bar) at Ambient of 130° F (54.4° C)
Ports:	1/2" (13 mm) Hose Barb and 1/2" (13 mm) Straight Pipe Thread
Motor:	Permanent Magnet with Thermal Overload Protection
Temperature:	Liquid temperature range is 45°F (7°C) to 130°F (54.4°C)
Viscosity:	250 centipoise maximum
Shipping Weight:	7 lb (3.2 kg) approx. (12/24 V models)

APPLICATIONS

This pump provides excellent service in the following applications.

CONSTRUCTION: Water supply pump to the spray bars of road rollers and other compaction equipment, street sweepers, and truck mounted dust control systems.

AGRICULTURAL: Supply pump for herbicide and pesticide spraying equipment.

INDUSTRIAL: Fluid transfer applications for mild acids and bases. Chemical feed pump. Washing fluid supply pump in parts washing systems. Machine coolant pump. Concrete saw lubricant supply pump. Recirculating pump in filtering systems.



Models 31820, 31821 Series

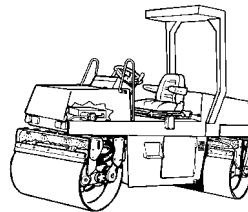

Road Rollers

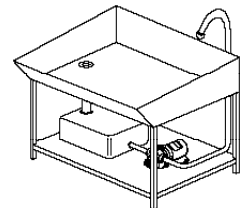

Parts Washing

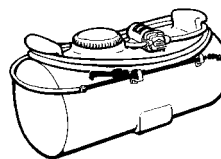

Spray Equipment

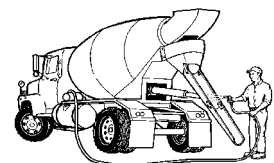

Construction Equipment Washdown

NOTE: Viton equipped models are not suitable for potable water applications.

CE Models	Flow GPM (LPM)	Voltage	Protective Coated Motor	Pressure Switch Settings		AMP Draw @ 10 psi	Recommended Fuse/Breaker Sizes
				Nominal psi (bar) Cut-In	(bar) Cut-Out		
31820-0492	3 (12)	12 Vdc	YES	N/A	N/A	5	15
31820-0494	3 (12)	24 Vdc	YES	N/A	N/A	2.5	7.5
31821-0492	3 (12)	12 Vdc	YES	25 (1.7)	40 (2.8)	5	15
31821-0494	3 (12)	24 Vdc	YES	25 (1.7)	40 (2.8)	2.5	7.5

* Viton is a registered trademark of DuPont Dow Elastomers L.L.C.

** Santoprene is a registered trademark of Monsanto.

OPERATING INSTRUCTIONS

⚠ WARNING  **Explosion hazard. Do not pump gasoline or other flammable liquids. To do so can cause an explosion resulting in injury or death.**

⚠ WARNING  **Fire hazard. Wiring must comply with applicable electrical standards and include a properly sized fuse or circuit breaker. Improper wiring can cause a fire resulting in injury or death.**

1. MOUNTING – JABSCO diaphragm pumps are self-priming and may be located in a dry location above or below the fluid supply. To vertically mount these units, it is best to do so with the motor on top. This will prevent fluid dripping on the motor in the event of a leak. Place pump on a solid surface and secure with four mounting screws being careful not to fully compress the rubber grommets which act as shock absorbers.

2. PLUMBING – Port adaptors are supplied to fit 1/2" (13 mm) dia. ID hose or 1/2" (13 mm) dia. straight pipe threads. Use Teflon* (PTFE) type tape when threading straight pipe threads to tapered pipe threads. Select two of the port adaptors supplied to match your plumbing system. Flexible hose or tubing is recommended instead of rigid piping at pump.

If you choose to use rigid piping, provide a short length of hose between pipe and the pump to avoid noise and vibration. Use clamps at both ends of hose to prevent air leaks. NOTE: Intake hose should be at least 1/2" (13 mm) ID reinforced hose.

A "Pumpgard" 36400-Series 1/2" (13 mm) or 36200-Series 3/4" (19 mm) in-line strainer should be installed between pump and fluid supply to keep debris out of system. Avoid any kinks or fittings which could cause excessive restrictions. Remember to periodically clean "Pumpgard" screens.

3. WIRING DC MODELS – In an easily accessible location, install an "on-off" switch (Jabsco 44960-Series) to control electricity to the pump. Turn the pump off when not used for extended periods, or when fluid supply is depleted.

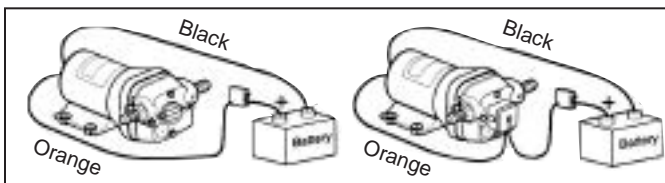

Select wire size from chart below. Use total length of wire from electrical source to pump and return. Chart allows for 3% voltage drop. If in doubt, use next larger wire size.

RECOMMENDED WIRE SIZES

Pump Voltage	Total Wire Length – feet (meters)		
	0-20 (0-6)	20-35 (6-11)	35-55 (11-17)
12 Volt	#14 AWG (2.5 mm ²)	#12 AWG (4 mm ²)	#10 AWG (6 mm ²)
24 Volt	#16 AWG (1.5 mm ²)	#14 AWG (2.5 mm ²)	#12 AWG (4 mm ²)

* TEFLON is a registered trademark of E.I. DuPont de Nemours and Company.

The electrical circuit should be protected with an over-current protection device in the positive lead. See chart for proper size. The pump circuit should not include any other electrical loads. Black Wire from the motor is negative, orange is positive.

If you are not familiar with applicable electrical standards, have the unit installed by a qualified electrician.

After installation, check the voltage at the pump motor. Voltage should be checked when pump is operating. Full voltage must be available at the pump motor at all times.

4. SELF-PRIMING – Pump is self-priming. Vertical dry lift capacity is 10 ft (3 m) (wet) 5 ft (1.5 m) (dry) min. Be sure suction piping is airtight or pump will not self-prime.

5. RUNNING DRY – Pump can run dry indefinitely without damage.

6. CHEMICAL COMPATIBILITY – Fluids being pumped must be compatible with the materials of construction. Consult factory for Chemical Compatibility Guide. Pump should be flushed with clean water or neutralizing solution after each use to prolong pump life.

7. PRESSURE – Maximum continuous duty discharge pressure is 40 psi with an ambient temperature no greater than 130°F (55°C).

NOTE: If the system operating pressure exceeds 50 psi, an external pressure relief valve should be installed in the system.

8. TEMPERATURE – The maximum recommended fluid temperature is 130°F (54°C). Minimum recommended fluid temperature is 45°F (7°C).

9. VISCOSITY – The maximum pumped fluid viscosity is 250 centipoise.

10. DUTY CYCLE – Motor and pump are designed for continuous operation in a 130°F (55°C) environment while pumping against 40 psi (2.8 bar) discharge pressure. Beyond these parameters, an intermitted duty cycle is recommended to maximize pump life. In normal operation, motor case will get hot. Prolonged contact with motor could cause a burn on human skin.

11. START-UP AND OPERATION – Check level of fluid in supply tank. Open all valves in system. Switch pump electrical circuit to "on" position. Flow will become steady as air is bled from system. For pumps equipped with pressure switch, close discharge valve after flow becomes steady fluid stream. Pump should shut off soon after closing valve. Pump is now ready for automatic operation. Pump will start when valve is opened and stop upon closure of valve. If pump is to be inoperative for a considerable period of time, flush pump with water, turn off electrical circuit to pump, and bleed system pressure by opening discharge valve.

⚠ CAUTION Pumps have thermal overload protected motors. The motor will automatically shut off as temperature rises due to an overload condition. If the motor shuts off in this manner, turn off electrical supply to pump. After a cooling off period, re-start pump.

SERVICE INSTRUCTIONS

PUMP DISASSEMBLY

1. Remove power from pump. Open discharge valve to relieve system pressure.
2. Push port clips back and disconnect plumbing from pump.
3. Remove the four (4) pumphead screws.
4. Rotate pumphead until cam/bearing set screw is visible through drain notch.
5. Loosen cam/bearing set screw and slide pump off motor shaft.
6. Separate upper housing, lower housing, and check valve assembly as required.

PUMP ASSEMBLY

1. Install new outer piston in lower housing with piston tops pointing away from motor.
2. Install new diaphragm in lower housing with the molded O-ring seals facing away from motor.
3. Insert each inner piston through the diaphragm into outer piston.
4. Turn each piston until fully seated.
5. Secure cam/bearing assembly to outer pistons using 18 inch pounds (2.0 Nm) of torque.
6. Slide lower housing on motor shaft. Align set screw with motor shaft indentation.
7. Set screw **MUST** be positioned over shaft indentation and secured tightly.

8. Check that ferrules are installed in upper housing and O-ring is properly seated.
9. Install check valve assembly in upper housing and fit upper and lower housings together.
10. Align pumphead with motor and tighten four (4) screws evenly using 25 inch pounds (2.8 Nm) of torque.

SWITCH REPLACEMENT

1. Remove power from pump. Relieve system pressure. Disconnect inlet and outlet hoses.
2. Remove pressure switch cover and disconnect power leads from switch.
3. Remove switch and switch diaphragm from pump by removing two (2) switch mounting screws.
4. Replace switch diaphragm and switch. Reassemble in reverse order.
5. Do not over tighten switch mounting screws.

OPTIONAL PORT KITS

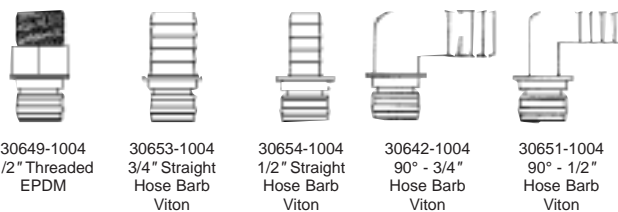

Port Kits contain two ports with O-rings

EXPLODED VIEW

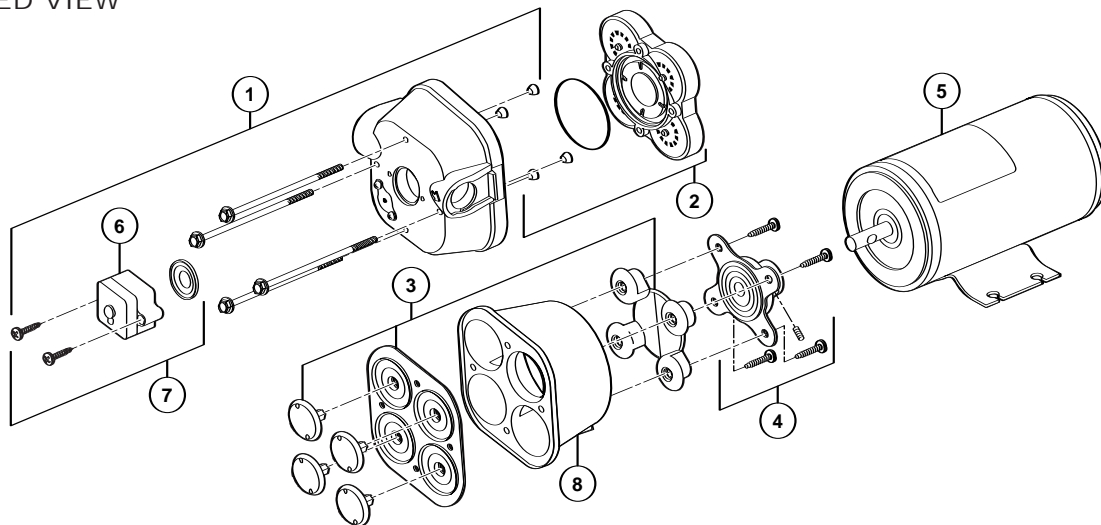

PARTS LIST

Model	① Upper Housing Kit	② Check Valve Kit	③ Diaphragm Kit	④ Cam/Bearing Kit	⑤ Motor Kit	⑥ Pressure Switch Kit
31820-0492	18910-4019	18911-7020	18912-3040	18913-0002	18919-0116	—
31820-0494	18910-4019	18911-7020	18912-3040	18913-0002	18919-1040	—
31821-0492	18910-4007	18911-7020	18912-3040	18913-0002	18919-0116	18916-0118
31821-0494	18910-4007	18911-7020	18912-3040	18913-0002	18919-1040	18916-0118

Bearing cover (7) not included in diaphragm Kit (3).

DIMENSIONS Inches (millimetres)

31820

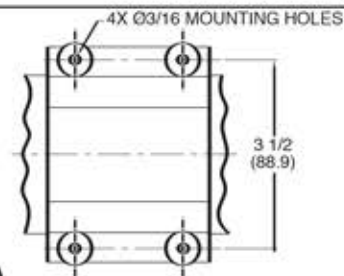
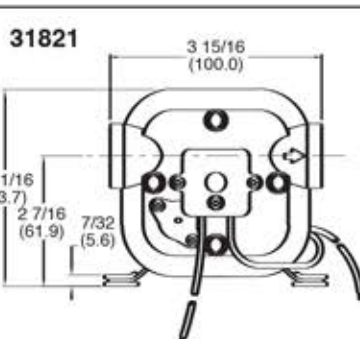
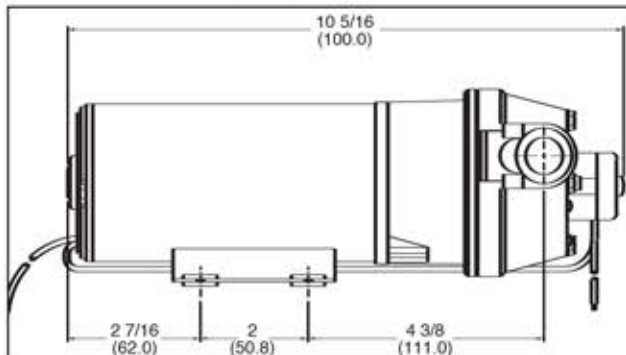
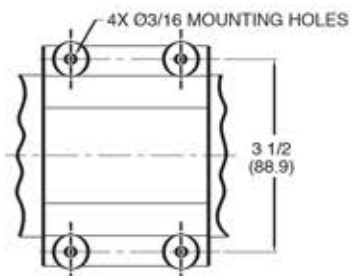
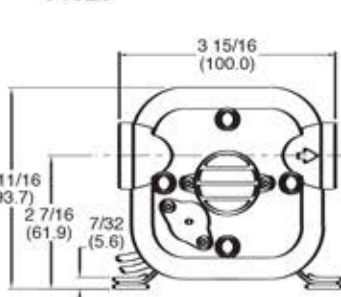
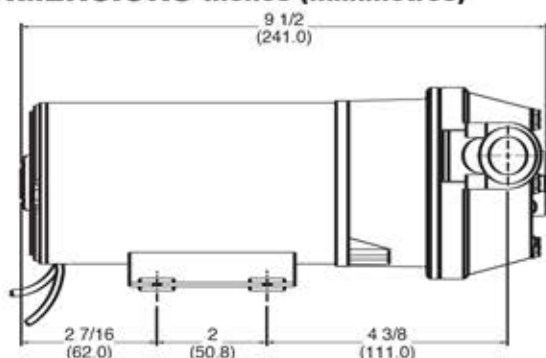

PERFORMANCE CURVES

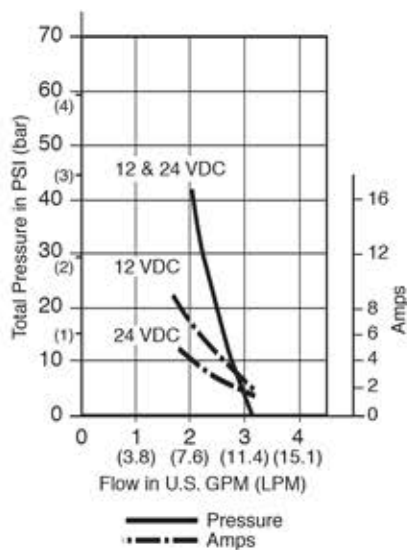

TROUBLESHOOTING

PULSATING FLOW – PUMP CYCLES ON AND OFF

- Restricted pump delivery.
Check discharge lines, fittings and valves for undersizing or clogging.

FAILURE TO PRIME – MOTOR OPERATES, BUT NO PUMP DISCHARGE

- Restricted intake or discharge line.
- Air leak in intake line.
- Punctured pump diaphragm.
- Debris under flapper valves.
- Crack in pump housing.

MOTOR FAILS TO TURN ON

- Loose wiring connection.
- Pump circuit has no power.
- Blown fuse/Thermal Protector Tripped.

- Pressure switch failure.
- Defective motor.

PUMP FAILS TO TURN OFF AFTER ALL VALVES ARE CLOSED

- Empty water tank.
- Punctured pump diaphragm.
- Discharge line leak.
- Defective pressure switch.
- Insufficient voltage to pump.
- Debris under flapper valves.

LOW FLOW AND PRESSURE

- Air leak at pump intake.
- Accumulation of debris inside pump and plumbing.
- Worn pump bearing (excessive noise).
- Punctured pump diaphragm.
- Defective motor.

CAUTION

Pumps have thermal overload protected motors. The motor will automatically shut off as temperature rises due to an overload condition. If the motor shuts off in this manner, close all nozzles, faucets or valves. After a cooling off period, the pump will automatically re-start.

Jabasco

www.jabasco.com

THE PRODUCTS DESCRIBED HEREIN ARE SUBJECT TO THE JABSCO ONE YEAR LIMITED WARRANTY, WHICH IS AVAILABLE FOR YOUR INSPECTION UPON REQUEST.

U.S.A.
Jabasco
20 Icon
Foothill Ranch, CA 92610
Tel: 949.859.4945
Fax: 949.859.1153

UNITED KINGDOM
Jabasco
Bingley Road, Hoddesdon
Hertfordshire EN11 0BU
Tel: +44 (0) 1992 450145
Fax: +44 (0) 1992 467132

CANADA
Fluid Products Canada
55 Royal Road
Guelph, Ontario N1H 1T1
Tel: 519 821.1900
Fax: 519 821.2569

JAPAN
NHK Jabasco Company Ltd.
3-21-10, Shin-Yokohama
Kohoku-Ku, Yokohama, 222
Tel: 045.475.8906
Fax: 045.475.8908

GERMANY
Jabasco GmbH
Oststrasse 28
22840 Norderstedt
Tel: +49-40-53 53 73 -0
Fax: +49-40-53 53 73 -11

ITALY
Jabasco Marine Italia
Via Tommaseo, 6
20059 Vimercate, Milano
Tel: +39 039 685 2323
Fax: +39 039 666 307