

P200A-5100 SERIES PUMPS 18mm Versions

Triplex Ceramic
Plunger Pump
Operating Instructions/
Repair and Service Manual

316 Stainless Steel Models:

P217A-5100, P218A-5100, P219A-5100,
P220A-5100, P221A-5100, P227A-5100,
P230A-5100

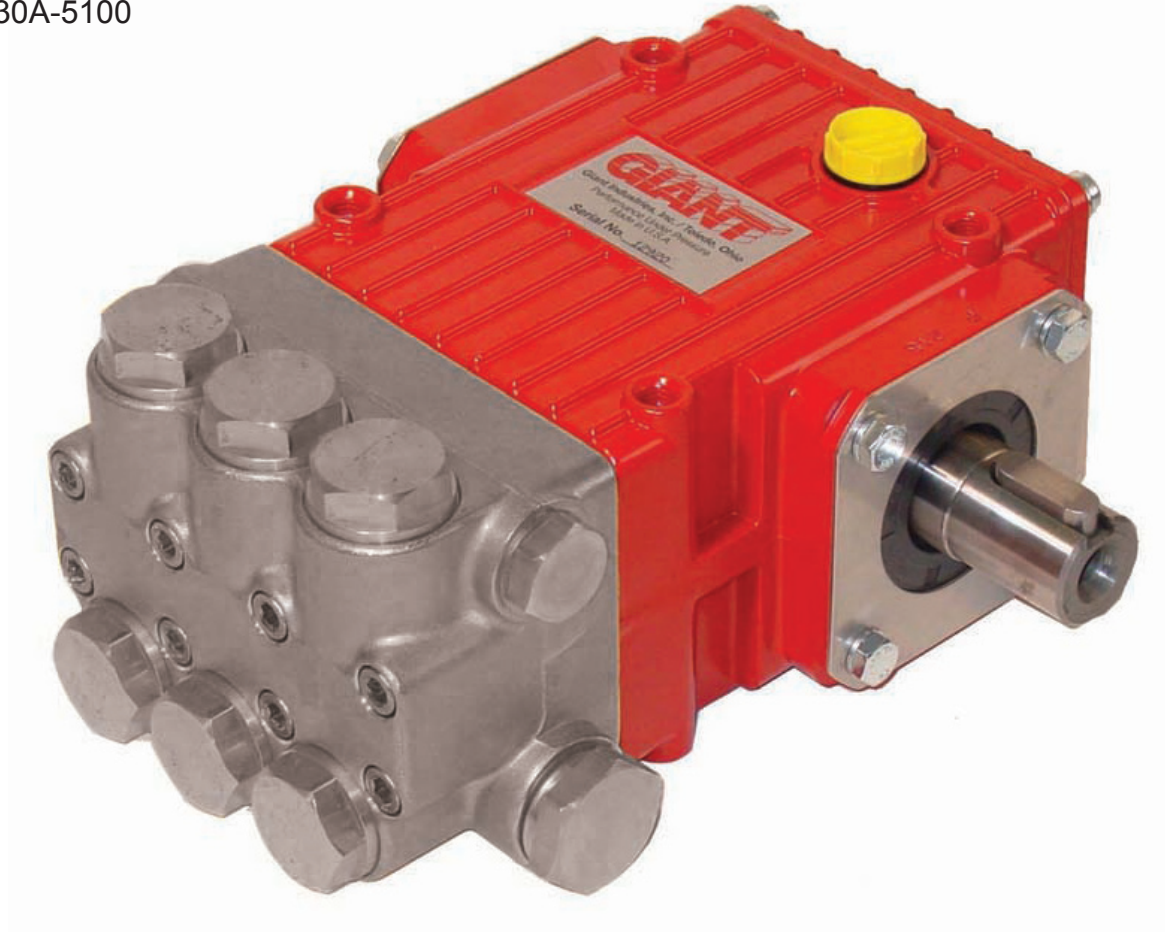

GIANT
Performance Under Pressure

Updated 10/13

Contents:

Installation Instructions:	page 2
Pump Specifications:	pages 3-9
Exploded View:	page 10
Parts List / Kits:	page 11
Repair Instructions:	pages 12-13
Torque Specifications:	page 13
Trouble Shooting Guide and Recommended Spare Parts List:	page 14
Dimensions:	page 15
Pump mounting selection Guide:	page 15
Warranty Information:	back page

INSTALLATION INSTRUCTIONS

Installation of the Giant Industries, Inc., pump is not a complicated procedure, but there are some basic steps common to all pumps. The following information is to be considered as a general outline for installation. If you have unique requirements, please contact Giant Industries, Inc. or your local distributor for assistance.

1. The pump should be installed flat on a base to a maximum of a 15° degree angle of inclination to ensure optimum lubrication.
2. The inlet to the pump should be sized for the flow rate of the pump with no unnecessary restrictions that can cause cavitation. Teflon tape should be used to seal all joints. If pumps are to be operated at temperatures in excess of 86°F (30° C), it is important to insure a positive head to the pump to prevent cavitation.
3. The discharge plumbing from the pump should be properly sized to the flow rate to prevent line pressure loss to the work area. It is essential to provide a safety bypass valve between the pump and the work area to protect the pump from pressure spikes in the event of a blockage or the use of a shut-off gun.

4. Use of a dampener is necessary to minimize pulsation at drive elements, plumbing, connections, and other system areas. The use of a dampener with Giant Industries, Inc. pumps is optional, although recommended by Giant Industries, Inc. to further reduce system pulsation. Dampeners can also reduce the severity of pressure spikes that occur in systems using a shut-off gun. A dampener must be positioned downstream from the unloader.

5. Crankshaft rotation on Giant Industries, Inc. pumps should be made in the direction designated by the arrows on the pump crankcase. Reverse rotation may be safely achieved by following a few guidelines available upon request from Giant Industries, Inc. Required horsepower for system operation can be obtained from the charts on pages 3-9.

6. Before beginning operation of your pumping system, remember: Check that the crankcase and seal areas have been properly lubricated per recommended schedules. Do not run the pump dry for extended periods of time. Cavitation will result in severe damage. Always remember to check that all plumbing valves are open and that pumped media can flow freely to the inlet of the pump.

Finally, remember that high pressure operation in a pump system has many advantages. But, if it is used carelessly and without regard to its potential hazard, it can cause serious injury.

IMPORTANT OPERATING CONDITIONS

Failure to comply with any of these conditions invalidates the warranty.

1. Prior to initial operation, add oil to the crankcase so that oil level is between the two lines on the oil dipstick. DO NOT OVERFILL.

Use Giant recommended Oil P/N 01153 (20W-50)

Crankcase oil should be changed after the first 50 hours of operation, then at regular intervals of 500 hours or less depending on operating conditions.

2. Pump operation must not exceed rated pressure, volume, or RPM. A pressure relief device must be installed in the discharge of the system.

3. Acids, alkalines, or abrasive fluids cannot be pumped unless approval in writing is obtained before operation from Giant Industries, Inc.

4. Run the pump dry approximately 10 seconds to drain the water before exposure to freezing temperatures.

Specifications

Model P217A-5100

	U.S.	(Metric)
1750 RPM *		
Ratings.....	1.85 GPM @ 2000 PSI.....	(7.0 LPM @ 140 bar)
3450 RPM *		
Ratings.....	3.6 GPM @ 2000 PSI.....	(13.8 LPM @ 140 bar)
Plunger Diameter.....	0.71"	18mm
Stroke	0.22"	5.5mm
Temperature of Pumped Fluids.....	Up to 86° F	(30° C)
Inlet Ports		(2) 1/2" BSP
Discharge Ports		(2) 3/8" BSP
Shaft Rotation		Top of Pulley Towards Fluid End
Crankshaft Diameter.....	0.94"	24mm
Key Width	0.31"	8mm
Shaft Mounting.....		Either Side
Weight.....	13 lbs. 4oz.	(6.0 kg)
Crankcase Oil Capacity	8.1 fl.oz.	(0.24 liters)
Volumetric Efficiency @ 1750 RPM.....		0.90
Mechanical Efficiency @ 1750 RPM		0.88

*15 PSI inlet pressure required

Consult the factory for special requirements that must be met if the pump is to operate beyond one or more of the limits specified above.

PULLEY INFORMATION

Pulley selection and pump speed are based on a 1725 RPM motor and "B" section belts. When selecting desired GPM, allow for a ±5% tolerance on pumps output due to variations in pulleys, belts and motors among manufacturers.

1. Select GPM required, then select appropriate motor and pump pulley from the same line.
2. The desired pressure is achieved by selecting the correct nozzle size that corresponds with the pump GPM.

HORSEPOWER INFORMATION

Horsepower ratings shown are the power requirements for the pump. Gas engine power outputs must be approximately twice the pump power requirements shown above.

We recommend that a 1.15 service factor be specified when selecting an electric motor as the power source. To compute specific pump horsepower requirements, use the following formula:

$$\frac{\text{GPM} \times \text{PSI}}{1450} = \text{HP}$$

P217A-5100 HORSEPOWER REQUIREMENTS						
RPM	GPM	800 PSI	1200 PSI	1500 PSI	1700 PSI	2000 PSI
1450	1.5	0.8	1.2	1.6	1.8	2.1
1750	1.8	1.0	1.5	1.9	2.1	2.5
3000	3.2	1.8	2.6	3.3	3.8	4.4
3200	3.4	1.9	2.8	3.5	4.0	4.7
3450	3.6	2.0	3.0	3.7	4.2	5.0

Specifications

Model P218A-5100

	U.S.	(Metric)
Volume	3.4 GPM	(12.8 LPM)
Discharge Pressure	2000 PSI	(140 bar)
Inlet Pressure	90 PSI	(6.2 bar)
RPM.....		Up to 1750 RPM
Plunger Diameter.....	0.71"	18mm
Stroke	0.39"	10.0mm
Temperature of Pumped Fluids	Up to 86° F	(30° C)
Inlet Ports		(2) 1/2" BSP
Discharge Ports		(2) 3/8" BSP
Shaft Rotation.....		Top of Pulley Towards Fluid End
Crankshaft Diameter.....	0.94"	24mm
Key Width	0.31"	8mm
Shaft Mounting		Either Side
Weight.....	13 lbs. 4 oz.	(6.0 kg)
Crankcase Oil Capacity	8.1 fl.oz.	(0.24 liters)
Volumetric Efficiency @ 1750 RPM.....		0.96
Mechanical Efficiency @ 1750 RPM		0.85

Consult the factory for special requirements that must be met if the pump is to operate beyond one or more of the limits specified above.

PULLEY INFORMATION

Pulley selection and pump speed are based on a 1725 RPM motor and "B" section belts. When selecting desired GPM, allow for a ±5% tolerance on pumps output due to variations in pulleys, belts and motors among manufacturers.

1. Select GPM required, then select appropriate motor and pump pulley from the same line.
2. The desired pressure is achieved by selecting the correct nozzle size that corresponds with the pump GPM.

HORSEPOWER INFORMATION

Horsepower ratings shown are the power requirements for the pump. Gas engine power outputs must be approximately twice the pump power requirements shown above. We recommend that a 1.15 service factor be specified when selecting an electric motor as the power source. To compute specific pump horsepower requirements, use the following formula:

$$\frac{\text{GPM} \times \text{PSI}}{1450} = \text{HP}$$

P218A-5100 HORSEPOWER REQUIREMENTS						
RPM	GPM	800 PSI	1200 PSI	1500 PSI	1700 PSI	2000 PSI
1150	2.2	1.2	1.8	2.3	2.6	3.0
1450	2.8	1.5	2.3	2.9	3.3	3.9
1750	3.4	1.9	2.8	3.5	4.0	4.7

Specifications

Model P219A-5100

	U.S.	(Metric)
Volume	4.2 GPM	(15.9 LPM)
Discharge Pressure	2000 PSI	(140 bar)
Inlet Pressure.....	90 PSI	(6.2 bar)
RPM.....		Up to 1750 RPM
Plunger Diameter.....	0.71"	18mm
Stroke	0.49"	12.4mm
Temperature of Pumped Fluids.....	Up to 86° F	(30° C)
Inlet Ports		(2) 1/2" BSP
Discharge Ports		(2) 3/8" BSP
Shaft Rotation.....		Top of Pulley Towards Fluid End
Crankshaft Diameter.....	0.94"	24mm
Key Width	0.31"	8mm
Shaft Mounting.....		Either Side
Weight.....	13 lbs. 4 oz.	(6.0 kg)
Crankcase Oil Capacity	8.1 fl.oz.	(0.24 liters)
Volumetric Efficiency @ 1750 RPM.....		0.96
Mechanical Efficiency @ 1750 RPM		0.85

Consult the factory for special requirements that must be met if the pump is to operate beyond one or more of the limits specified above.

PULLEY INFORMATION

Pulley selection and pump speed are based on a 1725 RPM motor and "B" section belts. When selecting desired GPM, allow for a ±5% tolerance on pumps output due to variations in pulleys, belts and motors among manufacturers.

1. Select GPM required, then select appropriate motor and pump pulley from the same line.
2. The desired pressure is achieved by selecting the correct nozzle size that corresponds with the pump GPM.

HORSEPOWER INFORMATION

Horsepower ratings shown are the power requirements for the pump. Gas engine power outputs must be approximately twice the pump power requirements shown above. We recommend that a 1.15 service factor be specified when selecting an electric motor as the power source. To compute specific pump horsepower requirements, use the following formula:

$$\frac{\text{GPM} \times \text{PSI}}{1450} = \text{HP}$$

P219A-5100 HORSEPOWER REQUIREMENTS						
RPM	GPM	800 PSI	1200 PSI	1500 PSI	1700 PSI	2000 PSI
1150	2.8	1.5	2.3	2.9	3.3	3.9
1450	3.5	1.9	2.9	3.6	4.1	4.8
1750	4.2	2.3	3.5	4.3	4.9	5.8

Specifications

Model P220A-5100

	U.S.	(Metric)
Volume.....	4.7GPM*	(17.6 LPM)*
Discharge Pressure	2000 PSI	(140 bar)
Inlet Pressure.....	90 PSI	(6.2 bar)
RPM.....		Up to 1750 RPM
Plunger Diameter.....	0.71"	18mm
Stroke	0.56"	14.1mm
Temperature of Pumped Fluids.....	Up to 86° F	(30° C)
Inlet Ports		(2) 1/2" BSP
Discharge Ports		(2) 3/8" BSP
Shaft Rotation.....		Top of Pulley Towards Fluid End
Crankshaft Diameter.....	0.94"	24mm
Key Width	0.31"	8mm
Shaft Mounting.....		Either Side
Weight.....	13 lbs. 4oz.	(6.0 kg)
Crankcase Oil Capacity	8.1 fl.oz.	(0.24 liters)
Volumetric Efficiency @ 1750 RPM.....		0.96
Mechanical Efficiency @ 1750 RPM		0.85

*Positive inlet pressure required

Consult the factory for special requirements that must be met if the pump is to operate beyond one or more of the limits specified above.

PULLEY INFORMATION

Pulley selection and pump speed are based on a 1725 RPM motor and "B" section belts. When selecting desired GPM, allow for a ±5% tolerance on pumps output due to variations in pulleys, belts and motors among manufacturers.

1. Select GPM required, then select appropriate motor and pump pulley from the same line.
2. The desired pressure is achieved by selecting the correct nozzle size that corresponds with the pump GPM.

HORSEPOWER INFORMATION

Horsepower ratings shown are the power requirements for the pump. Gas engine power outputs must be approximately twice the pump power requirements shown above. We recommend that a 1.15 service factor be specified when selecting an electric motor as the power source. To compute specific pump horsepower requirements, use the following formula:

$$\frac{\text{GPM} \times \text{PSI}}{1450} = \text{HP}$$

P220A-5100 HORSEPOWER REQUIREMENTS						
RPM	GPM	800 PSI	1200 PSI	1500 PSI	1700 PSI	2000 PSI
1150	3.1	1.7	2.6	3.2	3.6	4.3
1450	3.9	2.2	3.2	4.0	4.6	5.4
1750	4.7	2.6	3.9	4.9	5.5	6.5

Specifications

Model P221A-5100

	U.S.	(Metric)
1750 RPM *		
Ratings.....	2.34 GPM @ 2000 PSI.....	(8.9 LPM @ 140 bar)
3450 RPM *		
Ratings.....	4.6 GPM @ 2000 PSI.....	(17.6 LPM @ 140 bar)
Inlet Pressure.....	-4.35 to 145 PSI	(-0.3 to 10 bar)
RPM.....		Up to 3450 RPM
Plunger Diameter.....	0.71"	18mm
Stroke	0.28"	7.0mm
Temperature of Pumped Fluids.....	Up to 86° F.....	(30° C)
Inlet Ports		(2) 1/2" BSP
Discharge Ports		(2) 3/8" BSP
Shaft Rotation		Top of Pulley Towards Fluid End
Crankshaft Diameter.....		24mm
Key Width		8mm
Shaft Mounting.....		Right Side Facing Manifold
Weight.....	13 lbs. 4oz.....	(6.0 kg)
Crankcase Oil Capacity	8.1 fl.oz.....	(0.24 liter)
Volumetric Efficiency @ 1750 RPM.....		0.95
Volumetric Efficiency @ 3450 RPM.....		0.87
Mechanical Efficiency @ 1750 RPM		0.86

*Positive inlet pressure required

Consult the factory for special requirements that must be met if the pump is to operate beyond one or more of the limits specified above.

PULLEY INFORMATION

Pulley selection and pump speed are based on a 1725 RPM motor and "B" section belts. When selecting desired GPM, allow for a ±5% tolerance on pumps output due to variations in pulleys, belts and motors among manufacturers.

1. Select GPM required, then select appropriate motor and pump pulley from the same line.
2. The desired pressure is achieved by selecting the correct nozzle size that corresponds with the pump GPM.

HORSEPOWER RATINGS:

The rating shown are the power requirements for the pump. Gas engine power outputs must be approximately twice the pump power requirements shown above.

We recommend a 1.15 service factor be specified when selecting an electric motor as the power source. To compute specific pump horsepower requirements, use the following formula:

$$\frac{\text{GPM} \times \text{PSI}}{1450} = \text{HP}$$

P221A-5100 HORSEPOWER REQUIREMENTS				
RPM	GPM	1000 PSI	1500 PSI	2000 PSI
1450	2.0	1.4	2.1	2.8
1750	2.3	1.7	2.5	3.3
3000	4.1	2.8	4.2	5.7
3200	4.3	3.0	4.4	5.9
3450	4.7	3.2	4.9	6.5

Specifications

Model P227A-5100

	U.S.	(Metric)
1750 RPM *		
Ratings.....	2.1 GPM @ 2000 PSI	(8.0 LPM @ 140 bar)
3450 RPM *		
Ratings.....	3.8 GPM @ 2000 PSI	(14.4 LPM @ 140 bar)
Inlet Pressure.....	-4.35 to 145 PSI	(-0.3 to 10 bar)
RPM.....		Up to 3450 RPM
Plunger Diameter.....	0.71"	18mm
Stroke.....	0.25"	6.3mm
Temperature of Pumped Fluids.....	Up to 86° F	(30° C)
Inlet Ports.....		(2) 1/2" BSP
Discharge Ports.....		(2) 3/8" BSP
Shaft Rotation.....		Top of Pulley Towards Fluid End
Crankshaft Diameter.....		24mm
Key Width.....		8mm
Shaft Mounting.....		Right Side Facing Manifold
Weight.....	13 lbs. 4 oz.	(6.0 kg)
Crankcase Oil Capacity.....	8.1 fl.oz.	(0.24 liter)
Volumetric Efficiency @ 1750 RPM.....		0.95
Volumetric Efficiency @ 3450 RPM.....		0.87
Mechanical Efficiency @ 3450 RPM.....		0.86

*Positive inlet pressure required

Consult the factory for special requirements that must be met if the pump is to operate beyond one or more of the limits specified above.

PULLEY INFORMATION

Pulley selection and pump speed are based on a 1725 RPM motor and "B" section belts. When selecting desired GPM, allow for a ±5% tolerance on pumps output due to variations in pulleys, belts and motors among manufacturers.

1. Select GPM required, then select appropriate motor and pump pulley from the same line.
2. The desired pressure is achieved by selecting the correct nozzle size that corresponds with the pump GPM.

HORSEPOWER RATINGS:

The rating shown are the power requirements for the pump. Gas engine power outputs must be approximately twice the pump power requirements shown above.

We recommend a 1.15 service factor be specified when selecting an electric motor as the power source. To compute specific pump horsepower requirements, use the following formula:

$$\frac{\text{GPM} \times \text{PSI}}{1450} = \text{HP}$$

P227A-5100 HORSEPOWER REQUIREMENTS				
RPM	GPM	1000 PSI	1500 PSI	2000 PSI
1450	1.7	1.2	1.8	2.4
1750	2.1	1.4	2.2	2.9
3000	3.3	2.3	3.4	4.6
3200	3.5	2.4	3.6	4.9
3450	3.8	2.6	3.9	5.2

Specifications

Model P230A-5100

	U.S.	(Metric)
1750 RPM *		
Ratings.....	1.1 GPM @ 2000 PSI.....	(4.1 LPM @ 140 bar)
3450 RPM *		
Ratings.....	2.1 GPM @ 2000 PSI.....	(8.1 LPM @ 140 bar)
Inlet Pressure.....	14 to 145 PSI.....	(1 to 10 bar)
RPM.....		Up to 3450 RPM
Plunger Diameter.....	0.71".....	18mm
Stroke.....	0.13".....	3.4mm
Temperature of Pumped Fluids.....	Up to 86° F.....	(30° C)
Inlet Ports.....		(2) 1/2" BSP
Discharge Ports.....		(2) 3/8" BSP
Shaft Rotation.....		Top of Pulley Towards Fluid End
Crankshaft Diameter.....		24mm
Key Width.....		8mm
Shaft Mounting.....		Right Side Facing Manifold
Weight.....	13 lbs. 4 oz.....	(6.0 kg)
Crankcase Oil Capacity.....	8.1 fl.oz.....	(0.24 liter)
Volumetric Efficiency @ 1750 RPM.....		0.94
Volumetric Efficiency @ 3450 RPM.....		0.87
Mechanical Efficiency @ 3450 RPM.....		0.86

*Positive inlet pressure required

Consult the factory for special requirements that must be met if the pump is to operate beyond one or more of the limits specified above.

PULLEY INFORMATION

Pulley selection and pump speed are based on a 1725 RPM motor and "B" section belts. When selecting desired GPM, allow for a ±5% tolerance on pumps output due to variations in pulleys, belts and motors among manufacturers.

1. Select GPM required, then select appropriate motor and pump pulley from the same line.
2. The desired pressure is achieved by selecting the correct nozzle size that corresponds with the pump GPM.

HORSEPOWER RATINGS:

The rating shown are the power requirements for the pump. Gas engine power outputs must be approximately twice the pump power requirements shown above. We recommend a 1.15 service factor be specified when selecting an electric motor as the power source. To compute specific pump horsepower requirements, use the following formula:

$$\frac{\text{GPM} \times \text{PSI}}{1450} = \text{HP}$$

P230A-5100 HORSEPOWER REQUIREMENTS				
RPM	GPM	1000 PSI	1500 PSI	2000 PSI
1450	0.9	0.6	0.9	1.2
1750	1.1	0.8	1.1	1.5
3000	1.9	3.6	2.0	2.6
3200	2.0	3.8	2.1	2.8
3450	2.1	4.0	2.2	2.9

Exploded View - P200A-5100 Series

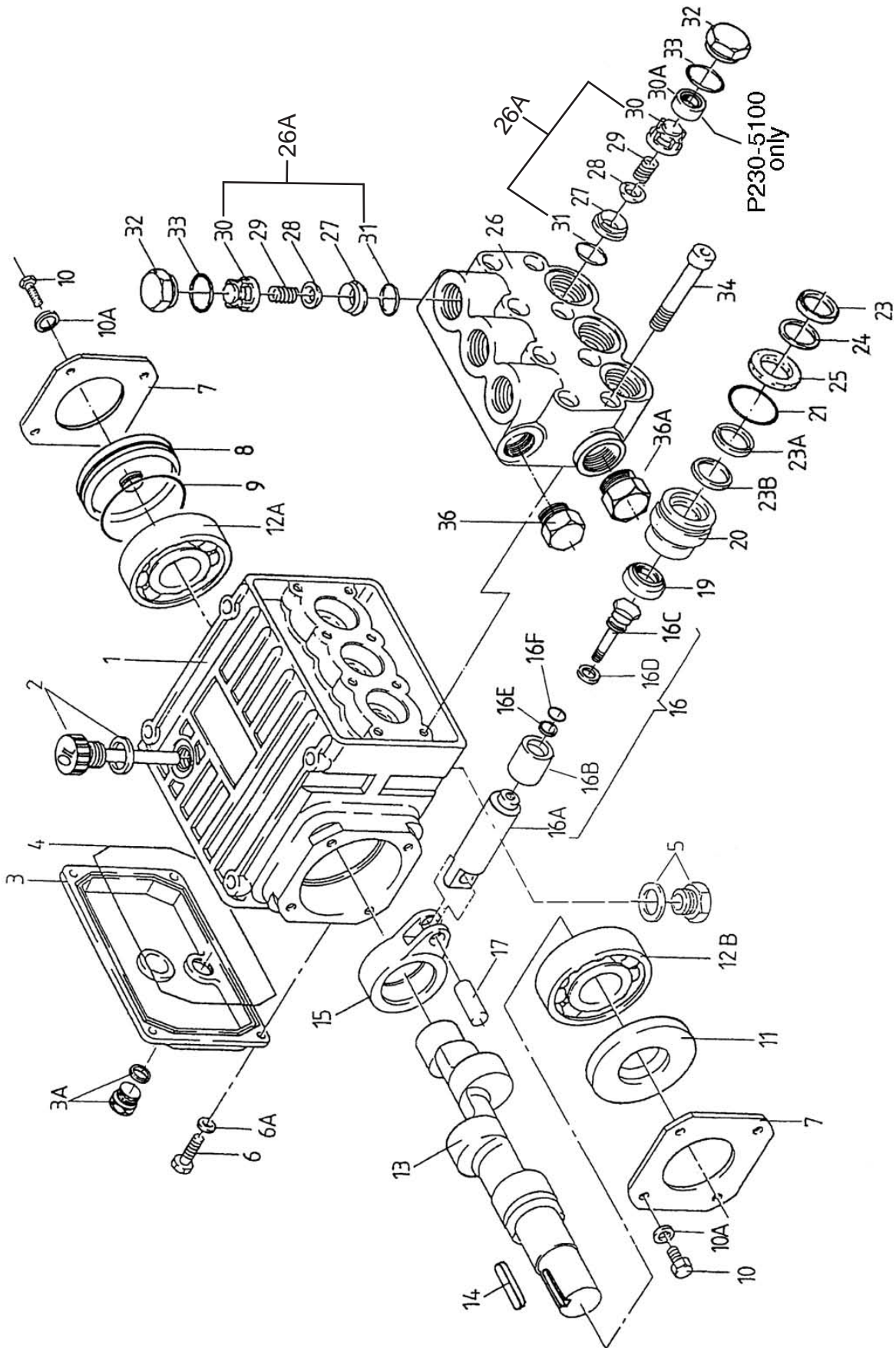

P200A-5100 SERIES PARTS LIST

<u>ITEM</u>	<u>PART NO.</u>	<u>DESCRIPTION</u>	<u>QTY.</u>	<u>ITEM</u>	<u>PART NO.</u>	<u>DESCRIPTION</u>	<u>QTY.</u>
1	08300A	Crankcase, Anodized	1	16F	07023	O-Ring	3
2	08301	Dipstick, Except P217-5100	1	17	08442	Wrist Pin	3
2	08480	Dipstick, P217-5100 Only	1	19	08356-0010	Oil Seal	3
3	08302A	Crankcase Cover, Anodized	1	20	08444A-0100	Seal Retainer, 316 S.S.	3
3A	07190-0100	Drain Plug & Gasket	1	21	08443	O-Ring (-5100)	3
4	08005	O-Ring	1	21	12260-0001	O-Ring, Viton (-5111/-5121)	3
5	08185-0100	Oil Drain Plug with seal	1	23	08477	Grooved Seal	
6	07188-0100	Screw, 316 S.S.	4			(P218/P219/P220-5100)	3
6A	07223-0100	Spring Washer, 316 S.S.	4	23	08087-0010	Grooved Seal, Viton	
7	08303	Bearing Cover	2			(P218/P219/P220-5111)	6
8	08490	Sight Glass	1	23	06704	Grooved Seal	
9	08492	O-Ring	1			(P217/P221/P227/P230-5100)	3
10	07225-0100	Screw	8	23	08087-0020	Grooved Seal, Teflon (-5121)	6
10A	07223-0100	Spring Washer	8	23A	08087	Grooved Seal Ring, Brown (-5100)	3
11	01166	Radial Shaft Seal	1	23B	06163	Drip Shield	3
12A	08020	Ball Bearing	1	24	07904	Pressure Ring	3
12B	01020	Ball Bearing	1	25	08445-0100	Weep Return Ring, 316 S.S.	3
13	08465	Crankshaft (P217A-5100)	1	26	06582-5000	Valve Casing	1
13	08440	Crankshaft (P218A-5100)	1	26A	07946-0100	Valve Assembly	6
13	08466	Crankshaft (P219A-5100)	1	27	07849-0100	Valve Seat	6
13	08467	Crankshaft (P220A-5100)	1	28	06809	Valve Plate	6
13	12258	Crankshaft (P221A-5100)	1	29	07906-0100	Valve Spring	6
13	06547	Crankshaft (P227A-5100)	1	30	07907	Valve Spring Retainer	6
13	06694	Crankshaft (P230A-5100)	1	30A	06824	Spacer Ring, P230-5100 Only	3
14	06207	Fitting Key	1	31	07853	O-Ring (-5100)	6
15	08333	Connecting Rod	3	31	07853-0001	O-Ring (-5111/-5121)	6
16	08469-0100	Plunger Assembly, Except P230-5100	3	32	07928-0100	Plug	6
16A	08468-0100	Plunger Base, 316 S.S.	3	33	07913	O-Ring (-5100)	6
16B	08455	Plunger	3	33	07913-0001	O-Ring (-5111/-5121)	6
16C	08456-0100	Tension Screw, 316 S.S.	3	34	08316-0100	Hex Head Cap Screw	8
16D	07204-0100	Crush Washer, 316 S.S.	3	36	12138	Plug, 3/8"	1
16E	07203	Support Ring	3	36A	07109-0400	Plug, 1/2"	1

P200A-5100 SERIES REPAIR KITS

Plunger Packing Kits

Part#09602 - P218A/P219A/P220A-5100

<u>Item</u>	<u>Part #</u>	<u>Description</u>	<u>Qty.</u>
23	08477	Grooved Seal	3
23A	08087	Grooved Seal Ring	3
23B	06163	Drip Shield	3
24	07904	Pressure Ring	3

Part#09602-0011-P218A/P219A/220A-5111

<u>Item</u>	<u>Part#</u>	<u>Description</u>	<u>Qty.</u>
23	08087-0010	Grooved Seal, Viton	6
23B	06163	Drip Shield	3
24	07904	Pressure Ring	3

Part#09602-0021-P218A/P219A/P220A-5121

<u>Item</u>	<u>Part#</u>	<u>Description</u>	<u>Qty.</u>
23	08087-0020	Grooved Seal, Teflon	6
23B	06163	Drip Shield	3
24	07904	Pressure Ring	3

Part#09756-P217A/P221A/P227A/230A-5100

<u>Item</u>	<u>Part#</u>	<u>Description</u>	<u>Qty.</u>
23	06704	Grooved Seal	3
23A	08087	Grooved Seal Ring	3
23B	06163	Drip Shield	3
24	07904	Pressure Ring	3

Valve Assembly Kit

Part # 09139 - For -5100 Series

<u>Item</u>	<u>Part #</u>	<u>Description</u>	<u>Qty.</u>
27	07849-0100	Valve Seat	6
28	06809	Valve Plate	6
29	07906-0100	Valve Spring	6
30	07907	Valve Retainer	6
31	07853	O-Ring	6
33	07913	O-Ring	6

Valve Assembly Kit

Part # 09139-0011 - For -5111/-5121

<u>Item</u>	<u>Part #</u>	<u>Description</u>	<u>Qty.</u>
27	07849-0100	Valve Seat	6
28	06809	Valve Plate	6
29	07906-0100	Valve Spring	6
30	07907	Valve Retainer	6
31	07853-0001	O-Ring	6
33	07913-0001	O-Ring	6

Oil Seal Kit

Part# 09144

<u>Item</u>	<u>Part #</u>	<u>Description</u>	<u>Qty.</u>
19	08356-0010	Oil Seal	3

REPAIR INSTRUCTION - P200A-5100 SERIES

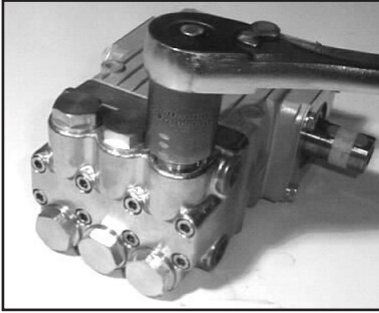

1. With a 22mm socket wrench, remove the (3) discharge valve plugs and (3) inlet valve plugs (32). Inspect the o-ring (33) for wear and replace if damaged.

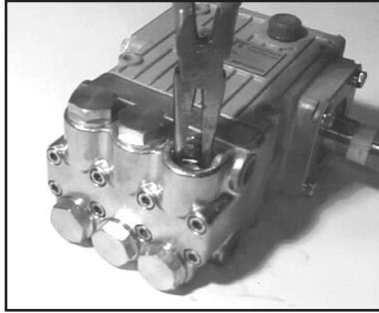

2. Using a needle nose pliers, remove the inlet and discharge valve assemblies (26A), for P230-5100 only, remove spacer (30A), and o-ring (31). Inspect all parts for wear and replace as necessary.



3. By inserting a small screw driver between the valve seat (27) and the valve spring retainer (30), the valve assembly can be separated.



4. Apply one drop of Loctite 243 to the valve plugs (32) and tighten to 33 ft.-lbs.

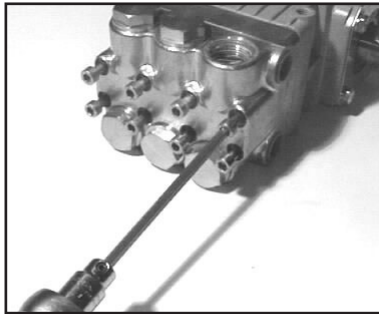

5. Next, use a 5mm allen wrench to remove the 8 socket head cap screws (34).

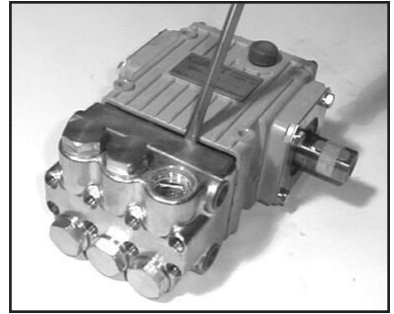

6. Carefully slide the valve casing (26) out over the plungers.

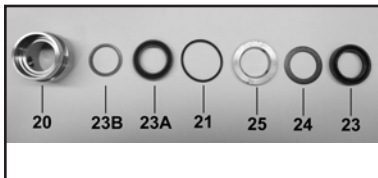

7. Remove the weep return ring (25), pressure ring (24), and v-sleeve (23) from the valve casing (26). Remove the rear v-sleeve (23A) and drip shield (23B) from the seal case (20). Inspect all parts, including o-ring (21) for wear and replace as necessary.



8. Check surfaces of plunger pipe (16B). A damaged surface will cause accelerated wear on the seals. Deposits of any kind must be carefully removed from the plunger surface. A damaged plunger must be replaced!



9. If the crankcase oil seals (19) are to be replaced, they can be removed by prying loose with a flat screwdriver. Take care not to make contact with the plunger.

REPAIR INSTRUCTION - P200A-5100 SERIES

Disassembly sequence of the *back* end of the P200A-5100 series pump.

- 1) Before you begin, drain the oil from the crankcase.
- 2) Remove the crankcase cover (3) and o-ring (4) from the crankcase (1). To remove the crankshaft (13), remove the bearing cover (7) and sight glass (8). Using a rubber mallet, remove the crankshaft axially through the connecting rods by tapping on the end of the shaft. Be careful not to bend or damage the connecting rods during crankshaft removal.
- 3) If the bearings (12A and 12B) and radial shaft seal (11) are still in the crankcase, remove them. Inspect both bearings and seal for wear and replace if necessary.
- 4) Remove the connecting rod (15) and plunger assembly(16). Remove the wrist pin (17) if necessary. Check the plunger bore in the crankcase for wear. Inspect parts and replace as necessary.
- 5) Should you find it necessary to service the plunger assembly (16) you can do so by removing the tension screw (16C). Replace crush washer (16D). **NOTE: Carefully flatten crush washer prior to replacing it. NOTE: Place side with line in the middle on the ceramic surface and use a hand press to cursh the washer prior to installing the tension screw.** Inspect all parts and replace as necessary.

Reassembly sequence of the P200A-5100 series pump

- 1) Reassemble plunger assembly (16) (apply a drop of Loctite to the tension screw (16C) threads) and the connecting rod (15) with wrist pin (17). Place assemblies in crankcase (1). Install crankshaft through connecting rods again being careful not to bend or otherwise damage the connecting rods.
- 2) Replace left and right side bearings (12A and 12B) if they were removed from the crankshaft. Be certain the bearings are pressed all the way onto the shaft and completely into the crankcase. Replace radial shaft seal (11), bearing cover (7), sight glass (8), and crankcase cover (3) with its o-ring (4).
- 3) If oil seals (19) were removed, replace with seal lip towards crankcase. Lubricate seal before replacing.
- 4) Replace seal case (20) with o-rings (21) over plungers. Generously lubricate o-rings and oil seal before reassembly. Replace drip shield (23B) and v-sleeve (23A) over plungers (16)..
- 5) Generously lubricate v-sleeve (23) and assemble into valve casing (26). Assemble weep return ring (25) and pressure ring (24) over plungers (16). Slide valve casing over plungers and seat firmly. Replace the eight socket head cap screws (34) and tighten to 105 inch-pounds in a crossing pattern (see below).
- 6) Re-install the six o-rings (31) and the six valve assemblies (27-30) and spacer ring (30A), P230-5100 only. Now replace the six valve plugs with o-rings (32 and 33) and tighten securely with a 22mm socket wrench to 33 foot-pounds.
- 7) Fill crankcase with 8.1 ounces of oil.

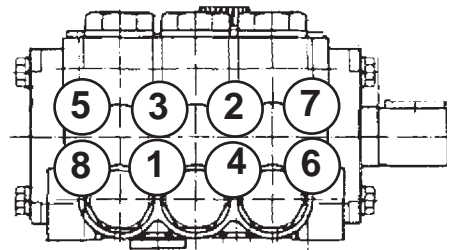

P200A-5100 SERIES TORQUE SPECIFICATIONS

<u>Position</u>	<u>Item#</u>	<u>Description</u>	<u>Torque Amount (ft.-lbs)</u>	<u>Nm</u>
16C	08456-0100	Tension Screw, Plunger	220 (in.-lbs.)	24.9 Nm
32	07928-0100	Valve Plug	33 (ft.-lbs.)	44.7 Nm
34	08316-0100	Hex Head Cap Screw, Valve Casing	105 (in.-lbs.)	11.9 Nm

PUMP SYSTEM MALFUNCTION

<u>MALFUNCTION</u>	<u>CAUSE</u>	<u>REMEDY</u>
The Pressure and/or the Delivery Drops	Worn packing seals Broken valve spring Belt slippage Worn or Damaged nozzle Fouled discharge valve Fouled inlet strainer Worn or Damaged hose Worn or Plugged relief valve on pump Cavitation Unloader	Replace packing seals Replace spring Tighten or Replace belt Replace nozzle Clean valve assembly Clean strainer Repair/Replace hose Clean, Reset, and Replace worn parts Check suction lines on inlet of pump for restrictions Check for proper operation
Water in crankcase	High humidity Worn seals	Reduce oil change interval Replace seals
Noisy Operation	Worn bearings oil with recommended lubricant Cavitation	Replace bearings, Refill crankcase Check inlet lines for restrictions and/or proper sizing
Rough/Pulsating Operation with Pressure Drop	Worn packing Inlet restriction Accumulator pressure Unloader Cavitation	Replace packing Check system for stoppage, air leaks, correctly sized inlet plumbing to pump Recharge/Replace accumulator Check for proper operation Check inlet lines for restrictions and/or proper size
Pressure Drop at Gun	Restricted discharge plumbing flow rate of pump	Re-size discharge plumbing to
Excessive Leakage	Worn plungers Worn packing/seals Excessive vacuum Cracked plungers Inlet pressure too high	Replace plungers Adjust or Replace packing seals Reduce suction vacuum Replace plungers Reduce inlet pressure
High Crankcase Temperature	Wrong Grade of oil Improper amount of oil in crankcase	Giant oil is recommended Adjust oil level to proper amount

Preventative Maintenance Check-List & Recommended Spare Parts List						
Check	Daily	Weekly	50hrs	Every 500 hrs	Every 1500 hrs	Every 3000 hrs
Oil Level/Quality	X					
Oil Leaks	X					
Water Leaks	X					
Belts, Pulley		X				
Plumbing		X				
Recommended Spare Parts						
Oil Change			X	X		
Seal Spare Parts (1 kit/pump) (See page 11 for kit list)					X	
Oil Seal Kit (1 kit/pump) (See page 11 for kit list)					X	
Valve Spare Parts (1 kit/pump) (See page 11 for kit list)						X

GIANT INDUSTRIES LIMITED WARRANTY

Giant Industries, Inc. pumps and accessories are warranted by the manufacturer to be free from defects in workmanship and material as follows:

1. For portable pressure washers and car wash applications, the discharge manifolds will never fail, period. If they ever fail, we will replace them free of charge. Our other pump parts, used in portable pressure washers and in car wash applications, are warranted for five years from the date of shipment for all pumps used in NON-SALINE, clean water applications.
2. One (1) year from the date of shipment for all other Giant industrial and consumer pumps.
3. Six (6) months from the date of shipment for all rebuilt pumps.
4. Ninety (90) days from the date of shipment for all Giant accessories.

This warranty is limited to repair or replacement of pumps and accessories of which the manufacturer's evaluation shows were defective at the time of shipment by the manufacturer. The following items are NOT covered or will void the warranty:

1. Defects caused by negligence or fault of the buyer or third party.
2. Normal wear and tear to standard wear parts.
3. Use of repair parts other than those manufactured or authorized by Giant.
4. Improper use of the product as a component part.
5. Changes or modifications made by the customer or third party.
6. The operation of pumps and or accessories exceeding the specifications set forth in the Operations Manuals provided by Giant Industries, Inc.

Liability under this warranty is on all non-wear parts and limited to the replacement or repair of those products returned freight prepaid to Giant Industries which are deemed to be defective due to workmanship or failure of material. A Returned Goods Authorization (R.G.A.) number and completed warranty evaluation form is required prior to the return to Giant Industries of all products under warranty consideration. Call (419)-531-4600 or fax (419)-531-6836 to obtain an R.G.A. number.

Repair or replacement of defective products as provided is the sole and exclusive remedy provided hereunder and the MANUFACTURER SHALL NOT BE LIABLE FOR FURTHER LOSS, DAMAGES, OR EXPENSES, INCLUDING INCIDENTAL AND CONSEQUENTIAL DAMAGES DIRECTLY OR INDIRECTLY ARISING FROM THE SALE OR USE OF THIS PRODUCT.

THE LIMITED WARRANTY SET FORTH HEREIN IS IN LIEU OF ALL OTHER WARRANTIES OR REPRESENTATION, EXPRESS OR IMPLIED, INCLUDING WITHOUT LIMITATION ANY WARRANTIES OR MERCHANTABILITY OR FITNESS FOR A PARTICULAR PURPOSE AND ALL SUCH WARRANTIES ARE HEREBY DISCLAIMED AND EXCLUDED BY THE MANUFACTURER.



GIANT INDUSTRIES, INC., 900 N. Westwood Ave., Toledo, Ohio 43607
Phone (419) 531-4600, Fax (419) 531-6836, www.giantpumps.com
© Copyright 2013 Giant Industries, Inc.